

DATA SHEET

S6EXP0025/075 Beamexpander

- magnification 2.5x
- for 355 nm
- fused silica
- standard coating

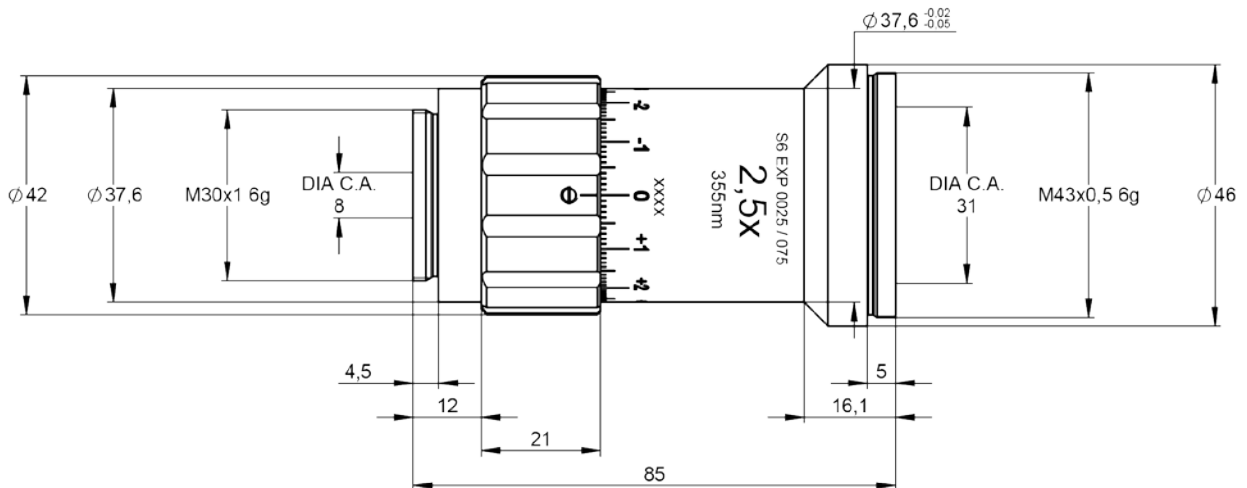

DATA SHEET



specifications

article number	S6EXP0025/075
design wavelength [nm]	355
magnification factor	2.5x
divergence adjustable	✓
optical principle	Galilei (no internal focus)
mounting thread	M30x1
pointing stability [mrad]	< 1
clear input aperture [mm]	8.0
clear output aperture [mm]	31.0
max. input beam diameter [mm]	6.0
wavefront error ¹⁾	< $\lambda/10$ for $1/e^2$ diameter ²⁾ of 6.0
total number of lenses	3
total transmission [%]	98
lens material	fused silica
LIDT (coating) [J/cm ²]	1.0 (1ns pulse at 50Hz)
no internal ghosts [✓/✗]	✓
no internal ghosts, reversed usage	✗
weight [kg]	0.20
accessory	S6MEC0107 - adapter M30x1 to C-mount

notes

- 1) Wavefront error peak to valley on axis proved by design
2) beam diameter vignetted at $1/e^2$

Data given by design

LIDT = Laser Induced Damage Threshold, valid for the coating at design wavelength and gaussian intensity profil